

WN 054418 45532
11/11

Art.Nr. 69011540

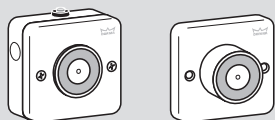

EM 500 A EM 500 G
EM 100 A EM 100 G
Art.Nr. 69011xxx Art.Nr. 69011xxx

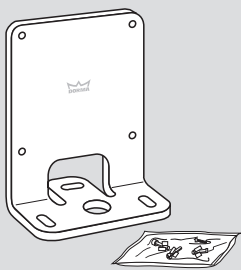
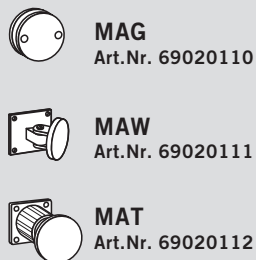

MAG
Art.Nr. 69020110
MAW
Art.Nr. 69020111
MAT
Art.Nr. 69020112

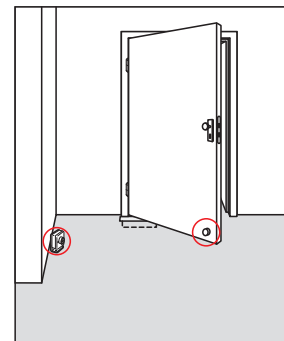

EM 500 A + MAG
EM 100 A + MAG

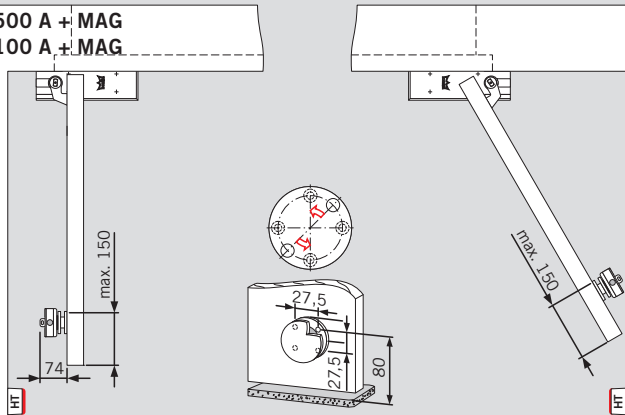

EM 500 A + MAT
EM 100 A + MAT

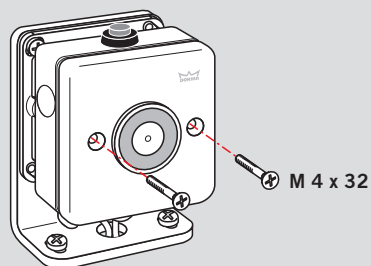
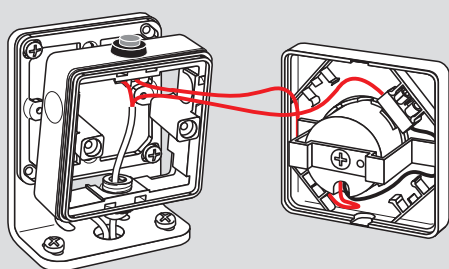
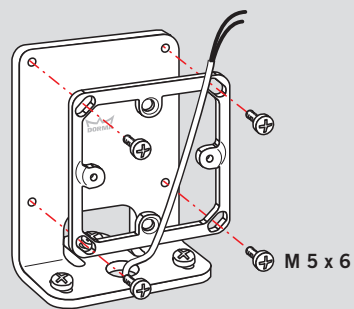
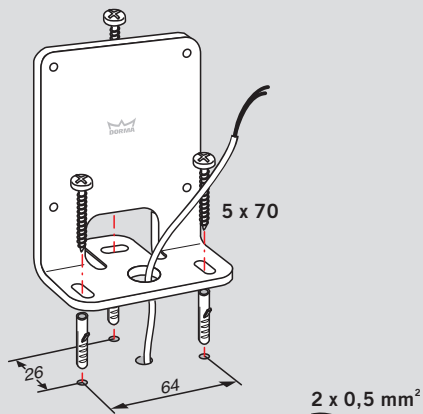
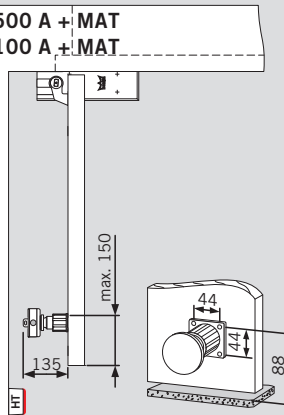

Art.Nr. 69011540

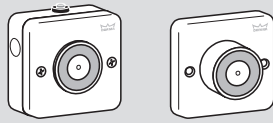
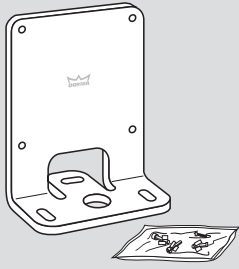

EM 500 A EM 500 G
EM 100 A EM 100 G
Art.Nr. 69011xxx Art.Nr. 69011xxx

MAG
Art.Nr. 69020110

MAW
Art.Nr. 69020111

MAT
Art.Nr. 69020112

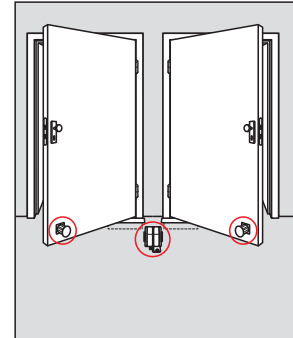

2 EM 500 A + 2 MAW
2 EM 100 A + 2 MAW

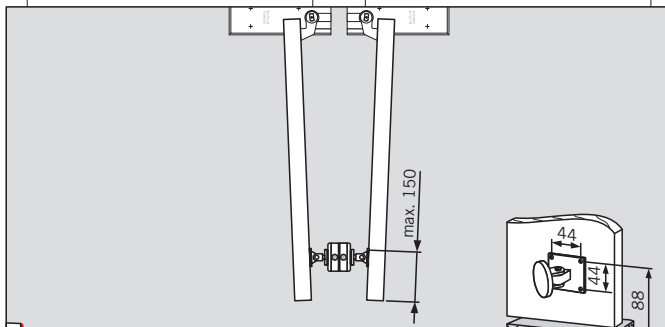

2 EM 500 A + 2 MAT
2 EM 100 A + 2 MAT

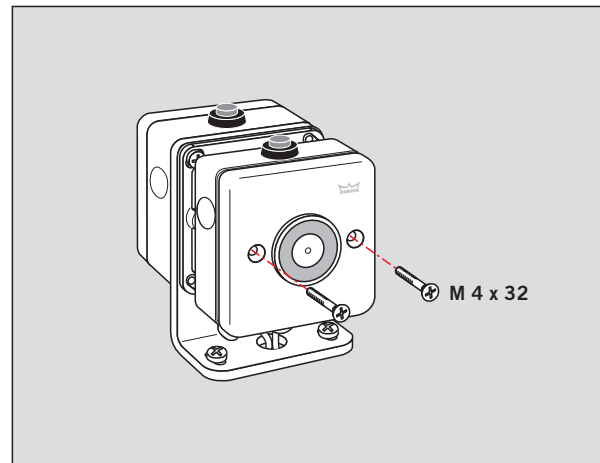
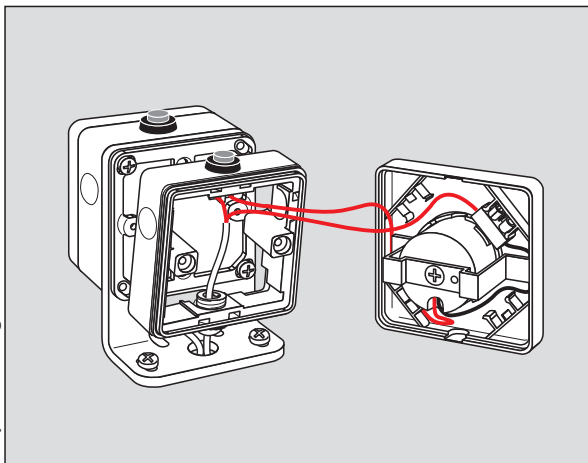
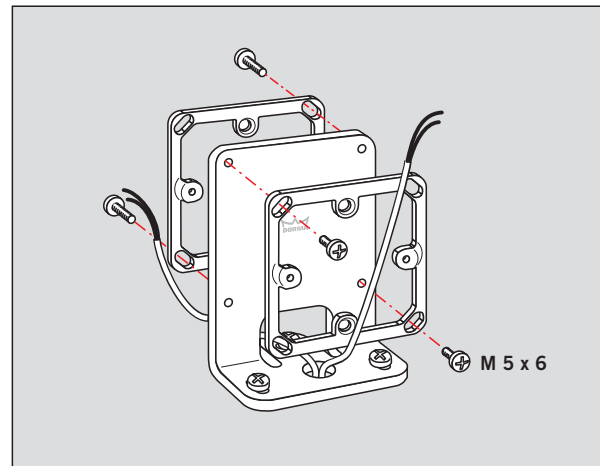
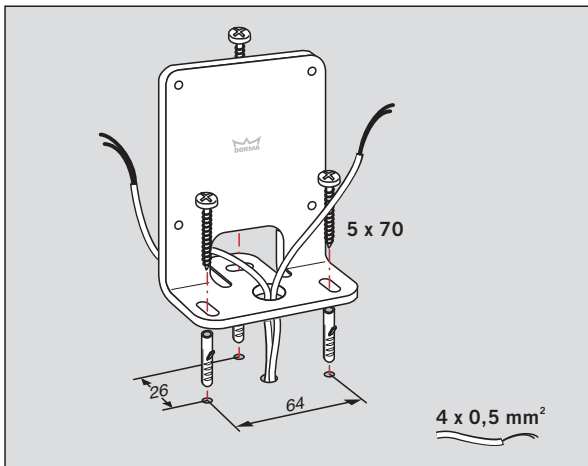
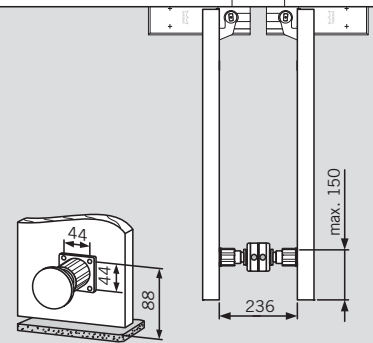

Änderungen vorbehalten
Subject to change without notice